

Electrical connectors

Harting connectors 1-10 pins.....	127
Harting connectors 1-16 pins.....	127
Harting connectors 1-24 pins.....	128
Harting connectors 1-32 pins.....	128
Control unit connectors	129
IPS	129
Knutsson.....	129
Susmic 51.....	129
Optinet.....	130
Opticontrol.....	130
MB-Engine	130
MB-Engine	131
Amp-Connectors.....	132
Deutsch-Connectors.....	133

Electrical connectors

We have compiled the connectors used in PONSSE forest machines under a single title. Using high-quality connector bodies and conductor contacts, you can prevent the connections from coming loose and the contact surfaces from oxidising, which could result in operational failures that are difficult to identify. The correct contacts in the correct connector body guarantee resistance-free connectors for years ahead.

Special pliers will be required for connecting conductor contacts to the conductor, depending on the connector type. Ponsse offers special low-cost pliers for making high-quality connections, also in field conditions.

Harting connectors 1-10 pins

0056005

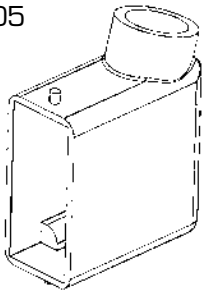

0061429 female

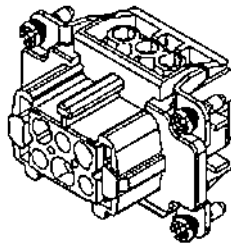

0056216

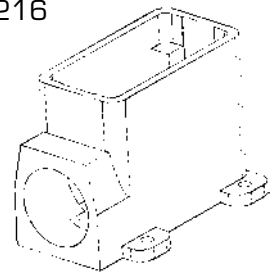

0055790

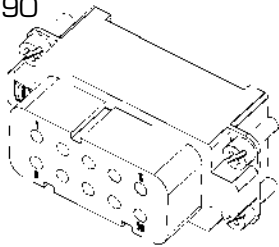

0061430 male

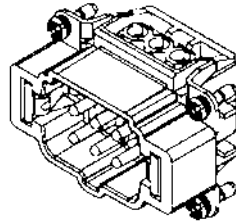

0055792

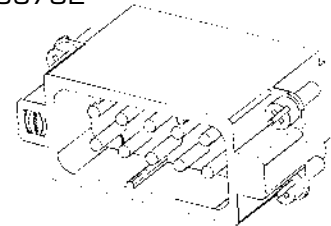

Harting connectors 1-16 pins

0056022

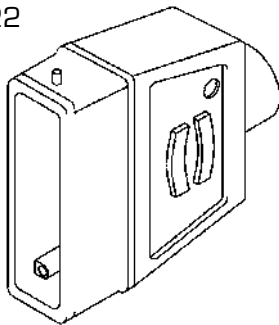

0043158

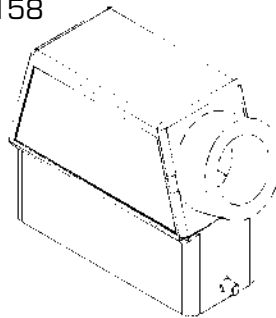

0056206

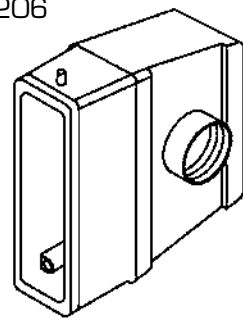

0056017

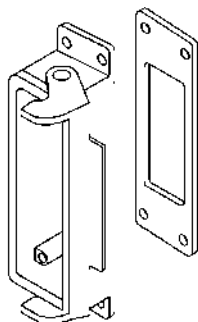

0017324

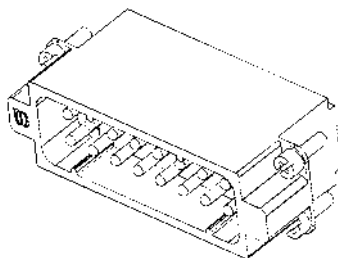

0017326

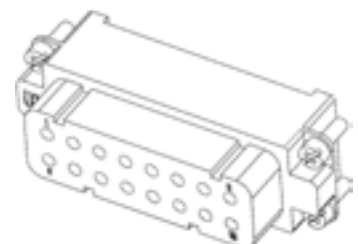

Harting connectors 1-24 pins

0017213

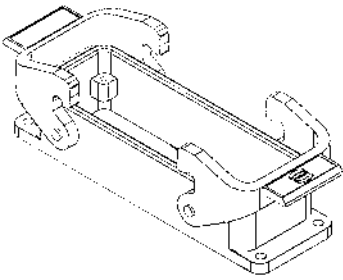

0017314

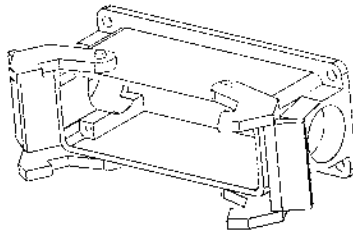

0044315

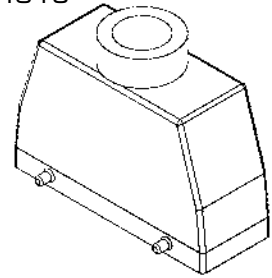

0056020

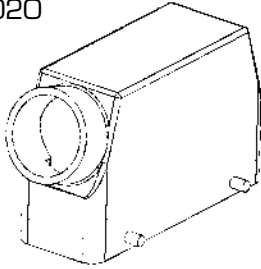

0017311

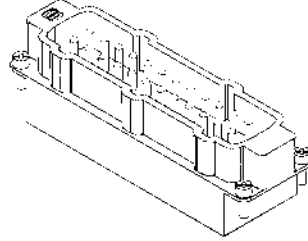

0017312

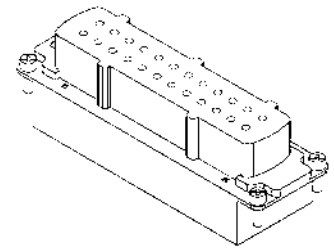

Harting connectors 1-32 pins

0044321

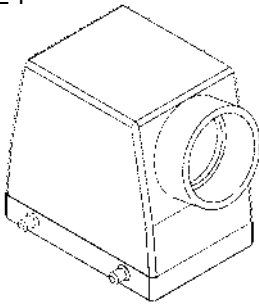

0017318

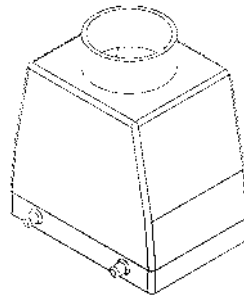

0056008

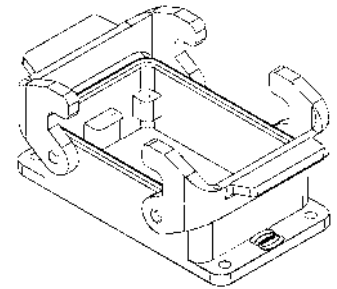

0017324, 1-16

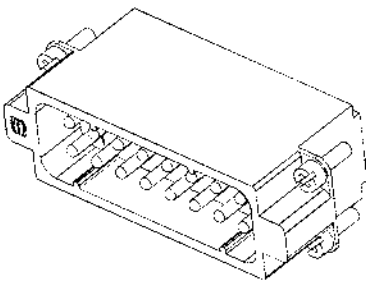

0017325, 17-32

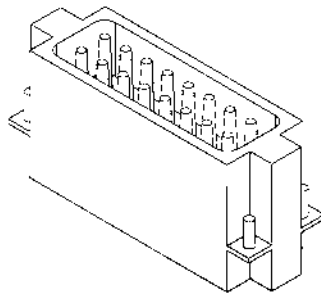

0017323

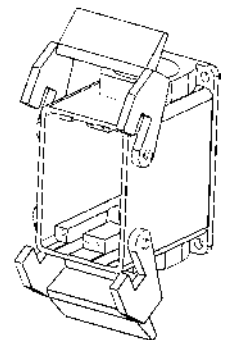

0017326, 1-16

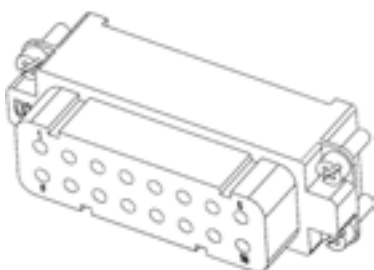

0017329, 17-32

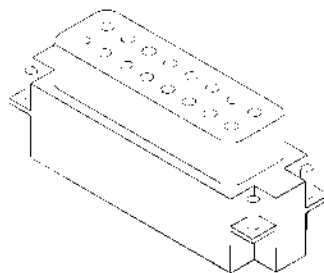

Control unit connectors

IPS

0056158 - GREEN
0055837 - WHITE

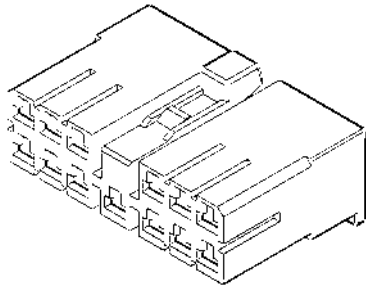

0057872

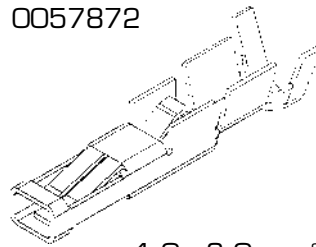

1.0 - 3.0 mm²

0055949

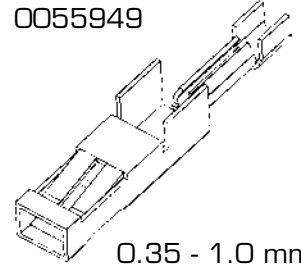

0.35 - 1.0 mm²

KNUTSSON

0057912

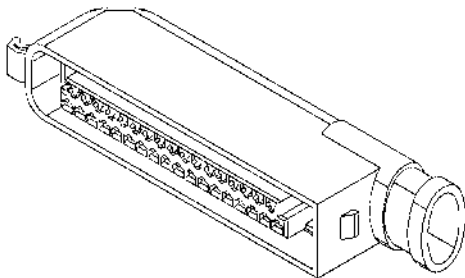

0057922

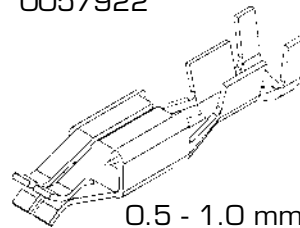

0.5 - 1.0 mm²

0058032

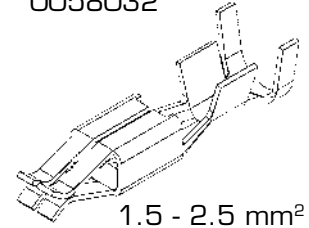

1.5 - 2.5 mm²

0056779

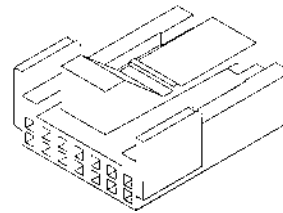

0056780

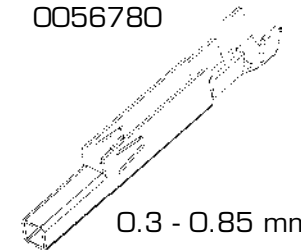

0.3 - 0.85 mm²

SUSMIC 51

0057911

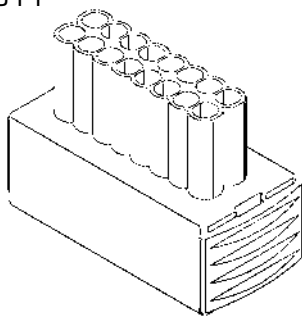

0057529

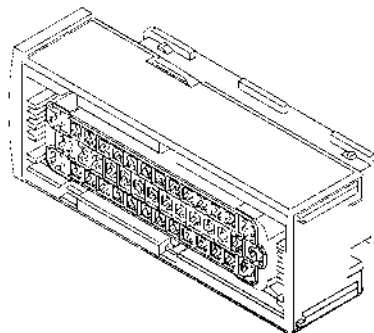

0057285

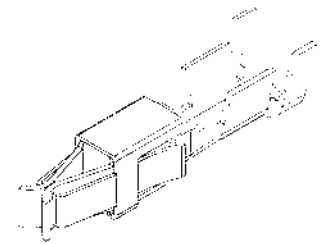

1.5 - 2.5 mm²

0057530

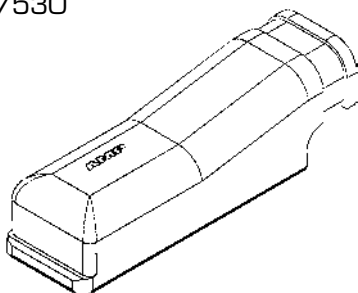

0057532

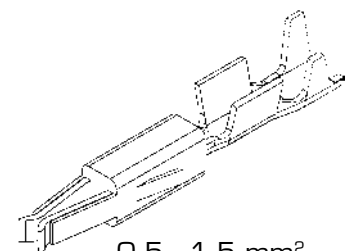

0.5 - 1.5 mm²

OPTINET

0057996

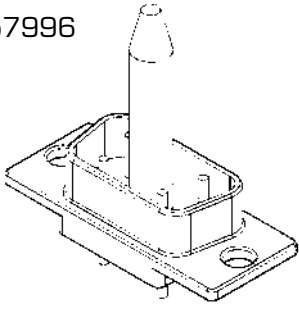

0057998

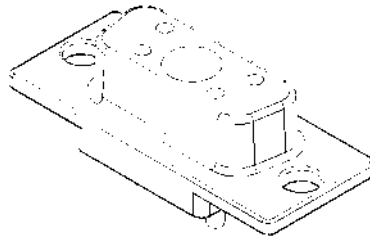

OPTICONTROL

0056176

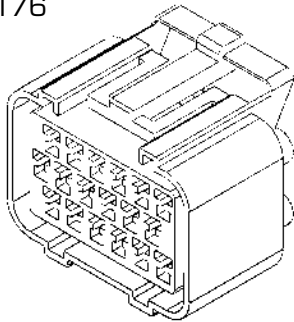

0056177

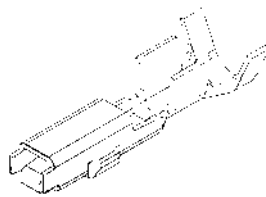

0.5 - 2.0 mm²

0058153

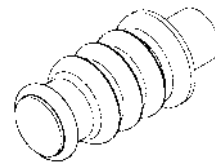

0057602

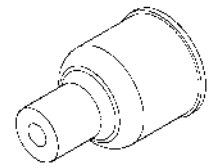

MB-ENGINE

MB - ADM2 - 12

0060018

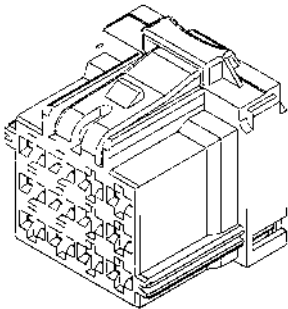

0060014

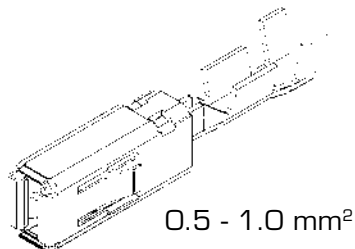

0.5 - 1.0 mm²

0060924

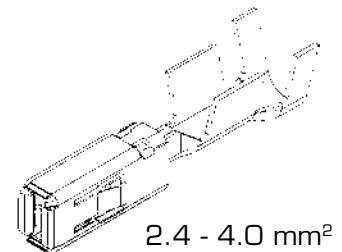

2.4 - 4.0 mm²

MB - ADM2 - 15

0060015

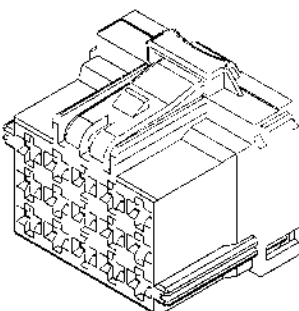

0060014

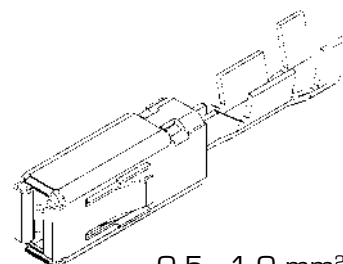

0.5 - 1.0 mm²

0060924

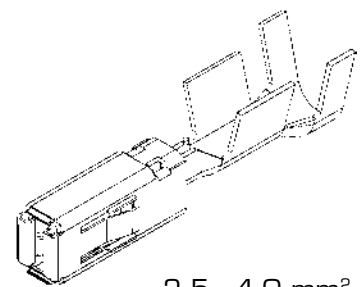

2.5 - 4.0 mm²

MB-ENGINE

MB - ADM2 - FLAME - CAN - 18

0060016

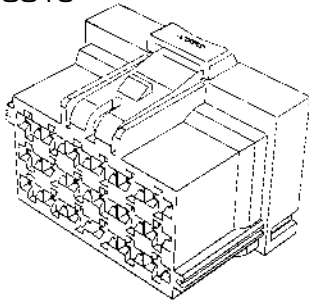

0060014

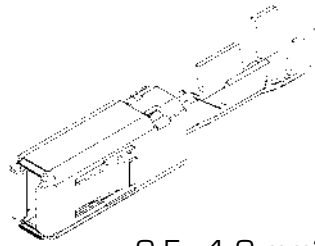

0.5 - 1.0 mm²

0060924

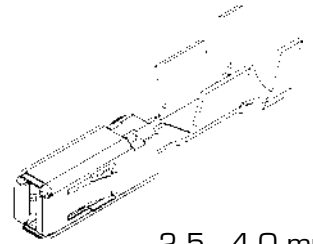

2.5 - 4.0 mm²

MB - ADM2 - 21

0060017

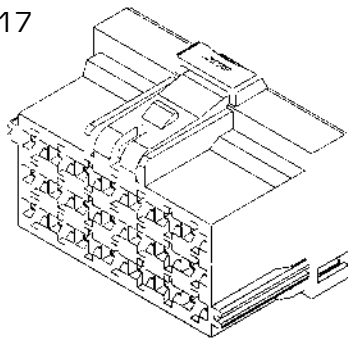

0060014

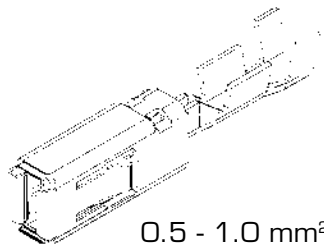

0.5 - 1.0 mm²

0060924

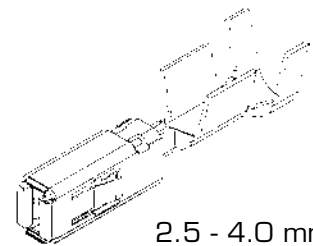

2.5 - 4.0 mm²

MINIDIAG

0060019

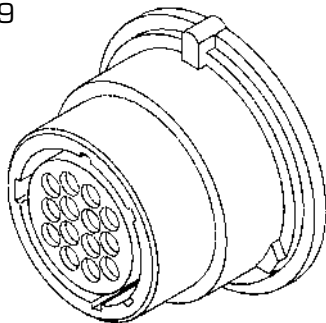

0060022

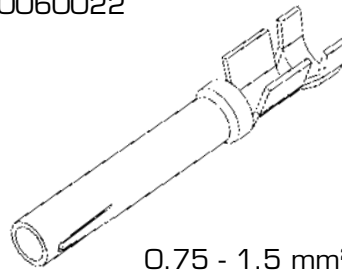

0.75 - 1.5 mm²

0060021

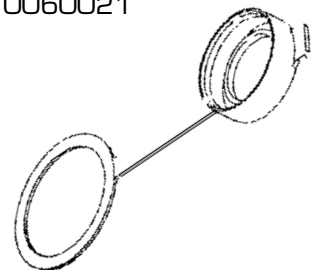

MB-PLD

0060566

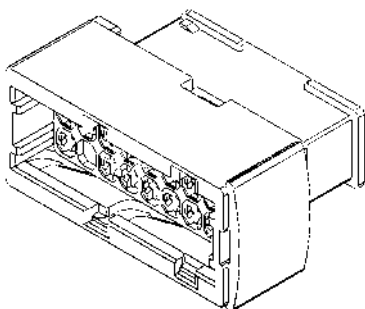

0060568

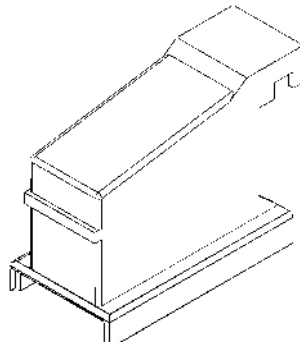

0060730
0.5 - 1.0 mm²

0060731
1.0 - 2.0 mm²

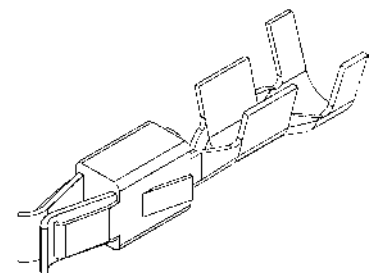

AMP-CONNECTORS

0025826

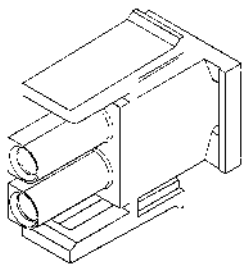

0025824

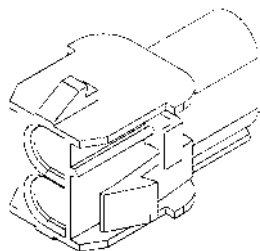

0025816

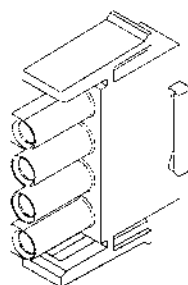

0025815

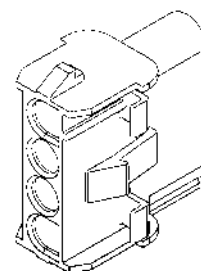

0025822

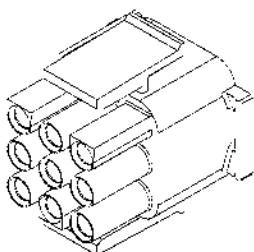

0025821

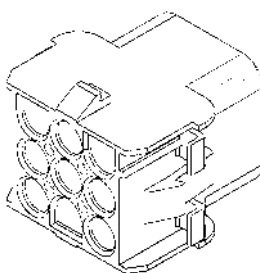

0025820

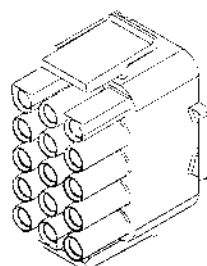

0025819

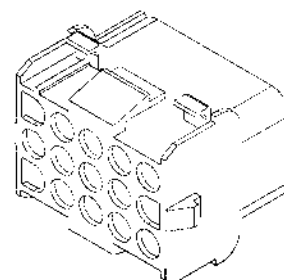

0056724 - male
3.0 - 6.0 mm²

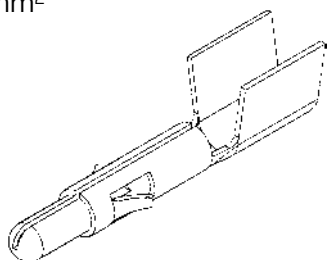

0025828 - male
0.5 - 2.0 mm²

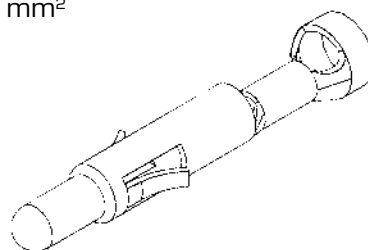

0055943 - female
0.5 - 2.1 mm²

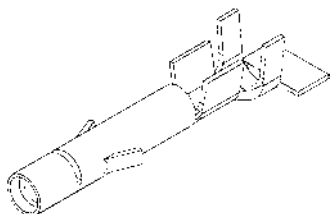

0025827 - female
0.5 - 2.0 mm²

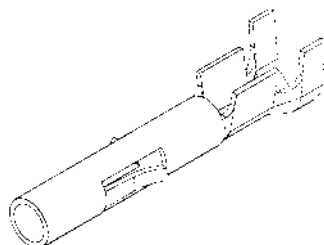

0056723 - female
3.0 - 6.0 mm²

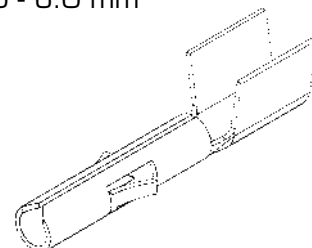

DEUTSCH-CONNECTORS

0064584

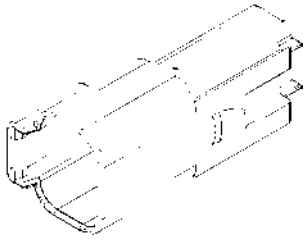

0064585

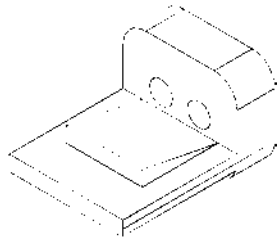

0064582

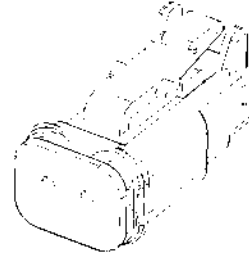

0064583

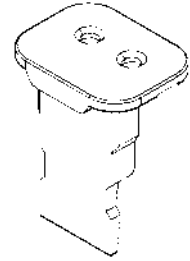

0064713

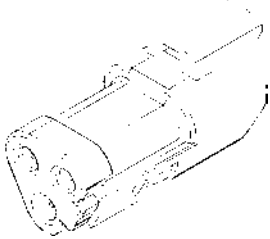

0064714

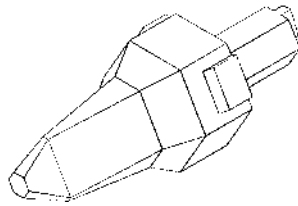

0064711

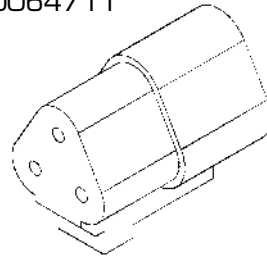

0064712

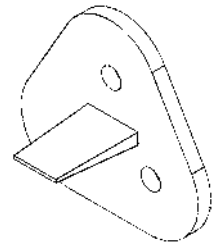

0064589

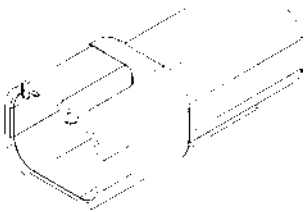

0064590

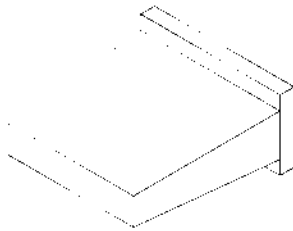

0064587

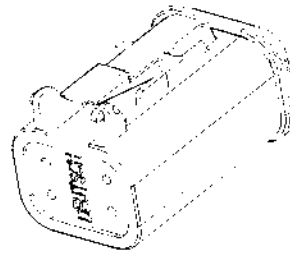

0064588

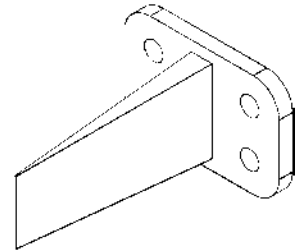

0064593

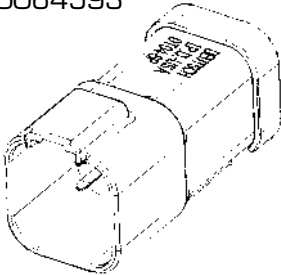

0064594

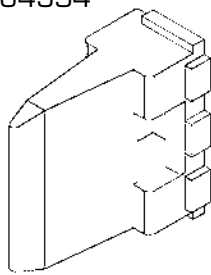

0064591

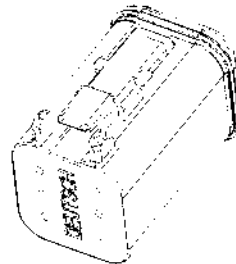

0064592

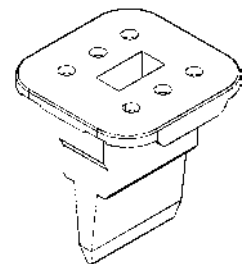

0064791

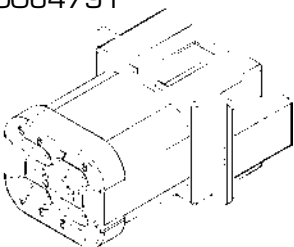

0064792

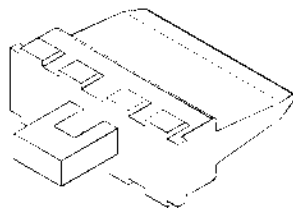

0064737

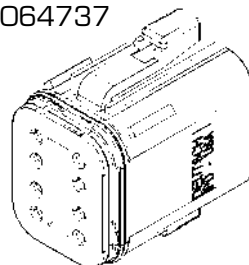

0064738

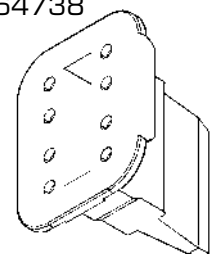

0064940 / 0.5 - 1.0 mm² golden, male
 0064724 / 0.75 - 1.5 mm² male
 0064722 / 1.5 - 2.5 mm² male

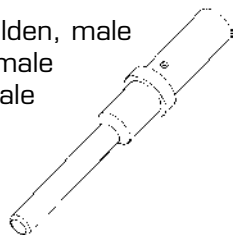

0064941 / 0.5 - 1.0 mm² golden, female
 0064723 / 0.75 - 1.5 mm² female
 0064721 / 1.5 - 2.5 mm² female

